

PATROL® - 103PET

COMBINED PIR & MW
DETECTOR WITH
PET IMMUNITY
UP TO 25KG
INSTALLATION
INSTRUCTIONS

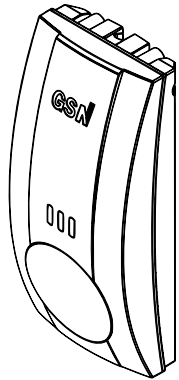

GSN Electronic Company Ltd.

1

PATROL-103PET

The professional combined passive infrared and microwave detector with dual element pyrosensor, which provides the most efficient security of residential and industrial premises.

PATROL-103PET with dual technology PIR & MW provides stable detection while virtually eliminating false alarms and costly service calls.

PATROL-103PET includes a shock sensor to detect external attack.

PATROL-103PET provides pet immune detection up to 25kg.

2

FEATURES

- HI-TECH DESIGN
- HIGH RFI & EMI IMMUNITY
- DIGITAL PROGRAM ALGORITHM OF SIGNAL PROCESSING
- DUAL TECHNOLOGY PIR & MW
- BUILT-IN SHOCK SENSOR (ADDITIONAL OPTION)
- IMMUNE TO PETS UP TO 25KG
- DOPPLER PULSE-COUNT SELECTION (1-5)
- HIGH LIGHT IMMUNITY
- INDIVIDUAL PIR AND MW SENSITIVITY ADJUSTMENT
- LOW OPERATING TEMPERATURE
- AUTOMATIC TEMPERATURE COMPENSATION

3

DETECTOR INSTALLATION

Fix the detector vertically on solid, flat wall surface. The installation height is 2 – 2.5 meters.

For corner or ceiling installations, you can use universal brackets – models: "UBL-1112" or "UBL-1115." (Additional purchase!)

For corner installation, use knockouts located on the sloping part of the detector base.

For protecting several windows, mount the detector at optimal distance from them. If heavy blinds of curtains cover the glass, locate the detector so the blinds will not block the sound.

4

INSTALLATION LIMITATIONS

- Do not install the detector on unstable or vibrating surfaces.
- Do not install the detector close to curtains, blinds or other items that vibrate with air movement.
- Do not install the detector close to air conditioners, air blast sources or above heat sources.
- Do not install the detector or route power wires and alarm loops next to high voltage cables.

5

PIR ADJUSTMENT

1. Remove the front cover.
2. Connect the power and wait for LED to stop flashing (warm-up time 60 sec).
3. Set Jumper W1 to the "PIR TEST" position, RELAY 1 is open.
4. Replace the cover.
5. Walk into the detector field-of-view. The red LED should flash with each step. Use the "PIR SENSITIVITY" potentiometer to adjust the PIR sensitivity, moving within the protected area.

6

MW ADJUSTMENT

1. Remove the front cover.
2. Set Jumper W1 to the "MW TEST" position, RELAY 1 is open.
3. Replace the cover.
4. Use the "MW SENSITIVITY" potentiometer to adjust the MW sensitivity, moving within the protected area. The green LED should flash with each step.

OPERATION MODE

1. Set Jumper W1 to "WORK" position.
2. Set regulator W6 according to animal weight.
3. Replace the cover – LED will blink 20 seconds. After this time, the detector is ready for operation.

7

CHANGING RELAY SWITCH CONNECTIONS

1. Disconnect the power.
2. Set Jumper W4 to "OFF" position.
3. Restore power.

PULSE-COUNTING METHOD

Selectable pulse count 1, 2, 3, 4, or 5 provides users with the option of optimizing detector sensitivity to suit the environment, thus retaining reliable performance at all times. To adjust pulse count for specific operating environments:

1. Remove Jumper W3.
- The green LED blinks indicating that pulse counting has begun.
2. Replace Jumper W3 during pause between LED blinking.

8

1. TERMINAL BLOCK
2. MW ANTENNA
3. W2 - ON/OFF LED JUMPER
4. W1 – JUMPER TO SELECT OPERATING AND TEST MODES
5. W4 - JUMPER TO SELECT NC/NO
6. W5 - ON/OFF SHOCK SENSOR JUMPER
7. W3 - PULSE PROGRAMMING JUMPER
8. PIR SENSITIVITY ADJUSTMENT
9. W6 - ANIMAL WEIGHT REGULATOR 15/25KG
10. MW CHANNEL SENSITIVITY ADJUSTMENT
11. S1 - TAMPER BUTTON
12. S2 - SHOCK SENSOR (ADDITIONAL OPTION)

9

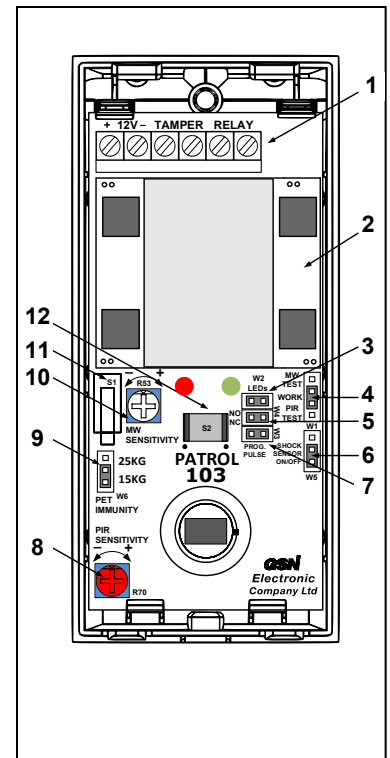

10

SHOCK SENSOR
(ADDITIONAL OPTION)

PATROL-103PET includes a shock sensor that detects external attack. Any physical impact or attempt to separate the detector from the wall will trigger an alarm signal to the control panel through the terminal «TAMPER».

Jumper W5 enables/disables the shock sensor.

- Jumper W5 On - Shock Sensor activated.
- Jumper W5 OFF - Shock Sensor disabled.

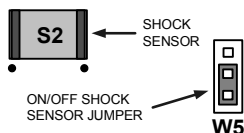

11

TERMINAL BLOCK CONNECTION

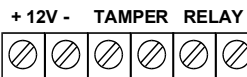

Terminals “+12V-“ – for connection to the power supply of the control unit.

Terminals “Tamper” – for connection to a 24-hour normally closed protective zone in the control unit.

Terminals “Relay” – PIR detector relay output.

12

WIDE ANGLE LENS

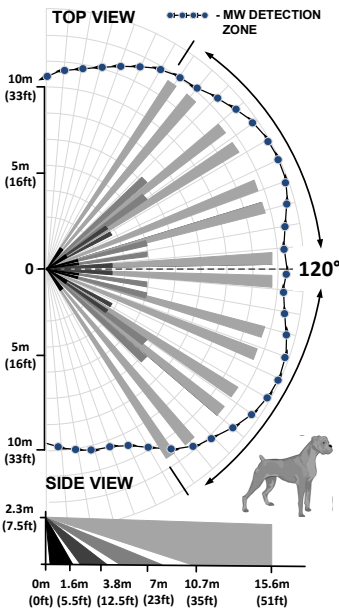

13

LONG RANGE LENS

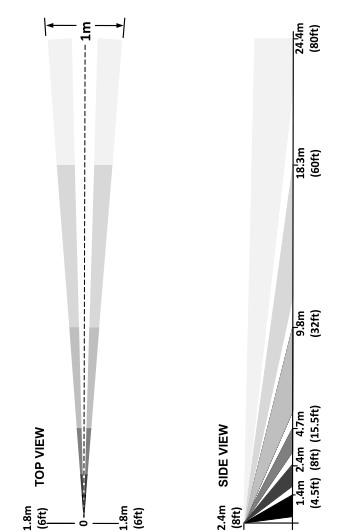

* Detection range for Patrol-103PET decreases up to 16 meters at using “Long range lense”

*ADDITIONAL PURCHASE

14

VERTICAL BARRIER LENS

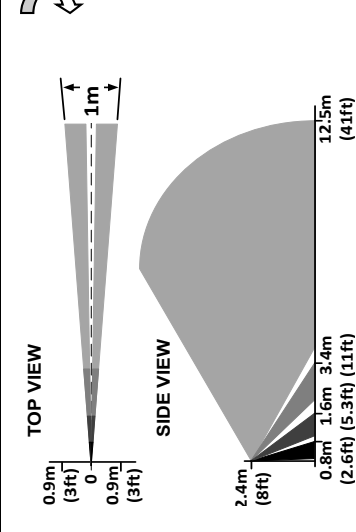

*ADDITIONAL PURCHASE

15

SUNSHIELD FILTER

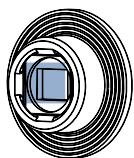

Sunshield filter for extra protection of detector pyroelectric sensor from sunlight and car headlights.

*ADDITIONAL PURCHASE

16

UNIVERSAL BRACKETS
“UBL-1112”, “UBL-1115”

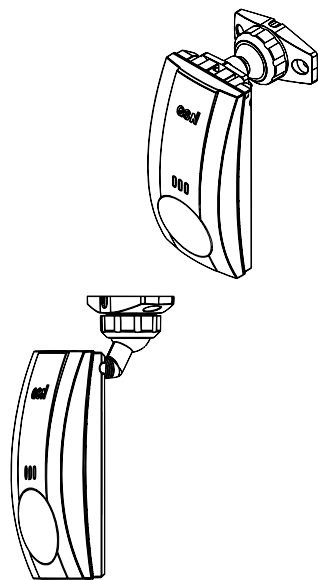

*ADDITIONAL PURCHASE

17

TECHNICAL SPECIFICATIONS

Input voltage.....9 – 16V
 Current consumption:
 In standby mode:17mA
 In alarm mode:.....55mA
 Microwave frequency:..10.525GHz
 Warm up period:.....60sec
 Detection range:.....15.6m x 120°
 Detection speed
 range:.....0.3 – 3 m/sec
 Relay output:.....
NC/NO; 60V; 100mA; 16Ω
 Tamper output:.....
NC; 60V; 100mA; 16Ω
 Alarm period:.....3sec
 Reset time:.....5 ± 1sec
 PET mode:.....15/25kg
 Pulse counter:.....1,2,3,4,5
 Installation height:.....2.0 – 2.5m

18

Light immunity without sunshield filter:.....no less than 6500 lux
 Light immunity with sunshield filter:.....more 30000 lux
 Operating temperature range:.....-30°C +60°C
 Storage temperature range:.....- 50°C – +80°C
 RFI immunity: 30V/m at a frequency range 30MHz-1GHz
 EMI immunity.....50,000V
 Dimensions:.....
54mm x 34mm x 120mm
 Weight:.....115gr.

19

WARRANTY

GSN Electronic Company Ltd. warrants the product to be free from defects in materials and workmanship under condition of observance of service regulations and to be repaired or replaced under absence of mechanical damages for a limited period of five years from the date of sale.

GSN Electronic Company Ltd.

7 ATARA ST.
 NAZARETH ILLIT 17802
 P.O.BOX 17719
 ISRAEL
 TEL: + (972) 4 6467152
 FAX: + (972) 4 6562414

WWW.GSNCOMPANY.COM

GSN@GSNCOMPANY.COM



P/N: USM0EPAT103PET_REV.A

20